

Haier®

Model # IPD-100

iPad / iPhone / iPod Docking Station Speaker System



USER MANUAL

TABLE OF CONTENTS

INTRODUCTION	1
IMPORTANT SAFETY INSTRUCTIONS	2-3
PREPARATION FOR USE	4
MAINTENANCE	4
USING THE AC ADAPTOR	5
CONNECTING EXTERNAL DEVICES	6
LOCATION OF CONTROLS & INDICATORS	7
REMOTE CONTROL	8
OPERATING INSTRUCTIONS	9
FUNCTION CONTROLS	9-10
VIDEO OPERATION	11
AppClockRadio(VIEW XL) OPERATION	12-17
TROUBLESHOOTING GUIDE	18
TECHNICAL SPECIFICATION	19
APPLE DEVICE COMPATIBILITY CHART	20
WARRANTY	21

INTRODUCTION

There are many exciting performance enhancements available by downloading the free AppClockRadio(VIEW XL) from the iTunes App Store.

For information on the AppClockRadio(VIEW XL) and how it works with your IPD-100, please visit the App Store and download the app Haier website.

Note: app is for iPad / iPhone / iPod touch only.

Download the FREE Clock Radio App to use these features:

- Enlarged display clock
- FM Tuner with 30 preset stations
- EQ function(3D / Jazz / Rock / Classic / Custom)
- Clock with multi Alarm / Sleep / Snooze
- Weather Report Display

IMPORTANT SAFETY INSTRUCTIONS

- 1.) Read these instructions. Keep these instructions. Follow all instructions. Heed all warnings.
- 2.) Install this unit in accordance with the manufacturer's instructions.
- 3.) Only use attachments / accessories specified by the manufacturer.
- 4.) Use only with the cart, stand, tripod, bracket, or table specified by the manufacturer, or sold with the unit. When a cart is used, use caution when moving the cart/unit combination to avoid injury from tip-over.
- 5.) Use replacement parts as specified by the manufacturer.
- 6.) Do not install this unit near any heat sources such as radiators, heat registers, stoves, or other apparatus (including amplifiers) that produce heat.
- 7.) The unit shall not be exposed to dripping or splashing water and no object filled with liquids, such as vases, shall be placed on the apparatus.
- 8.) Do not use this apparatus near water and clean the unit with dry cloth only.
- 9.) Disconnect the unit from the power source when cleaning.
- 10.) No naked flame sources, such as lighted candles, should be placed on the unit.
- 11.) Keep the player clean and never store it next to a heat source or in dirty, humid or wet places. Keep it out of direct sunlight.
- 12.) Do not block any ventilation openings; the ventilation should not be impeded by covering the ventilation openings with items, such as newspapers, table-cloths, curtains, etc. Give minimum 100 mm distances around the apparatus for sufficient ventilation.
- 13.) To prevent fire or shock hazard, do not expose this unit to rain or moisture.
- 14.) Do not subject the product to harsh impacts. Do not drop the appliance. This may result in damage to the product and loss of data.
- 15.) Care required with the use of this apparatus in extreme climates.
- 16.) Do not use this apparatus in an extremely dry environment, as this can lead to static discharge which can damage the player.
- 17.) This unit may be subject to inoperability to a strong electromagnetic field or other interference. If this occurs, turn the unit's power off, then disconnect the power plug from the "DC IN" on back of unit. After a few minutes, reconnect the power jack into "DC IN" input to reset the unit software, and the unit should return to normal operation.
- 18.) To prevent fire or shock hazard, do not use this plug with an extension cord, receptacle or other outlet unless the blades can be fully inserted to prevent blade exposure.
- 19.) Unplug this unit during lightning storms or when unused for long periods of time.
- 20.) Where the MAINS plug is used as the disconnect device, the disconnect device shall remain readily operable.

IMPORTANT SAFETY INSTRUCTIONS

- 21.) Do not destroy the polarized or grounding-type plug. A polarized plug has two blades with one wider than the other. A grounding type plug has two blades and a third grounding prong. The wide blade or the third prong is provided for your safety. If the provided plug does not fit into your outlet, do not attempt to force the plug, consult an electrician for replacement of the obsolete outlet.
- 22.) Protect the power cord from being walked on or pinched particularly at plugs, receptacles, and the point where they exit from the apparatus.
- 23.) Do not overload wall outlet. Only use power source as indicated.
- 24.) Upon completion of any service or repairs to this product, ask the service technician to perform safety checks.
- 25.) Refer all servicing to qualified service personnel. Servicing is required when the unit has been damaged in any way, such as power-supply cord is damaged. Liquid has been spilled into the unit, the unit has been exposed to rain or moisture, or has been dropped, and does not operate normally.
- 26.) Batteries shall not be exposed to excessive heat such as sunshine, fire or the like.
- 27.) Attention should be drawn to the environmental aspects or battery disposal.
- 28.) This product is not intended for commercial use. Household use only.
- 29.) Do not install this apparatus in a confined space, such as a book case or built-in cabinet. Maintain minimum distance(about 10cm) around the apparatus for sufficient ventilation.
- 30.) To completely turn off the power, the main plug of the apparatus must be disconnected from the wall outlet.

Servicing:

- This unit contains no user serviceable parts. Refer to qualified personnel.
- Consult your dealer if you are ever in doubt about the installation, operation or safety of this product.

PREPARATION FOR USE

Contents:

1x Main Unit, 1x Remote control, 1x Instruction manual, 1x Main adaptor

Unpacking And Set Up

- Remove the contents from the box and remove all packing material from the main unit. We recommend that you save the box & packing material in the event that the unit ever needs to be returned under warranty.
- Do not remove any labels or stickers from the back panels.

MAINTENANCE

Cleaning The Unit

- To prevent fire or shock hazard, disconnect your unit from the main power source when cleaning.
- If the cabinet becomes dusty wipe it with a soft dry cloth. Do not use any wax or polish sprays on the cabinet.
- If the cabinet becomes dirty or smudged with fingerprints, it may be cleaned with a soft cloth. Never use abrasive cloths or polishes, which will damage the finish of your unit.

Caution: Never allow any water or other liquids to get inside the unit while cleaning.

USING THE AC ADAPTOR

Connect the single plug into the “DC IN” jack on the unit’s back panel. Then, connect the AC Adaptor into the 120V AC outlet.

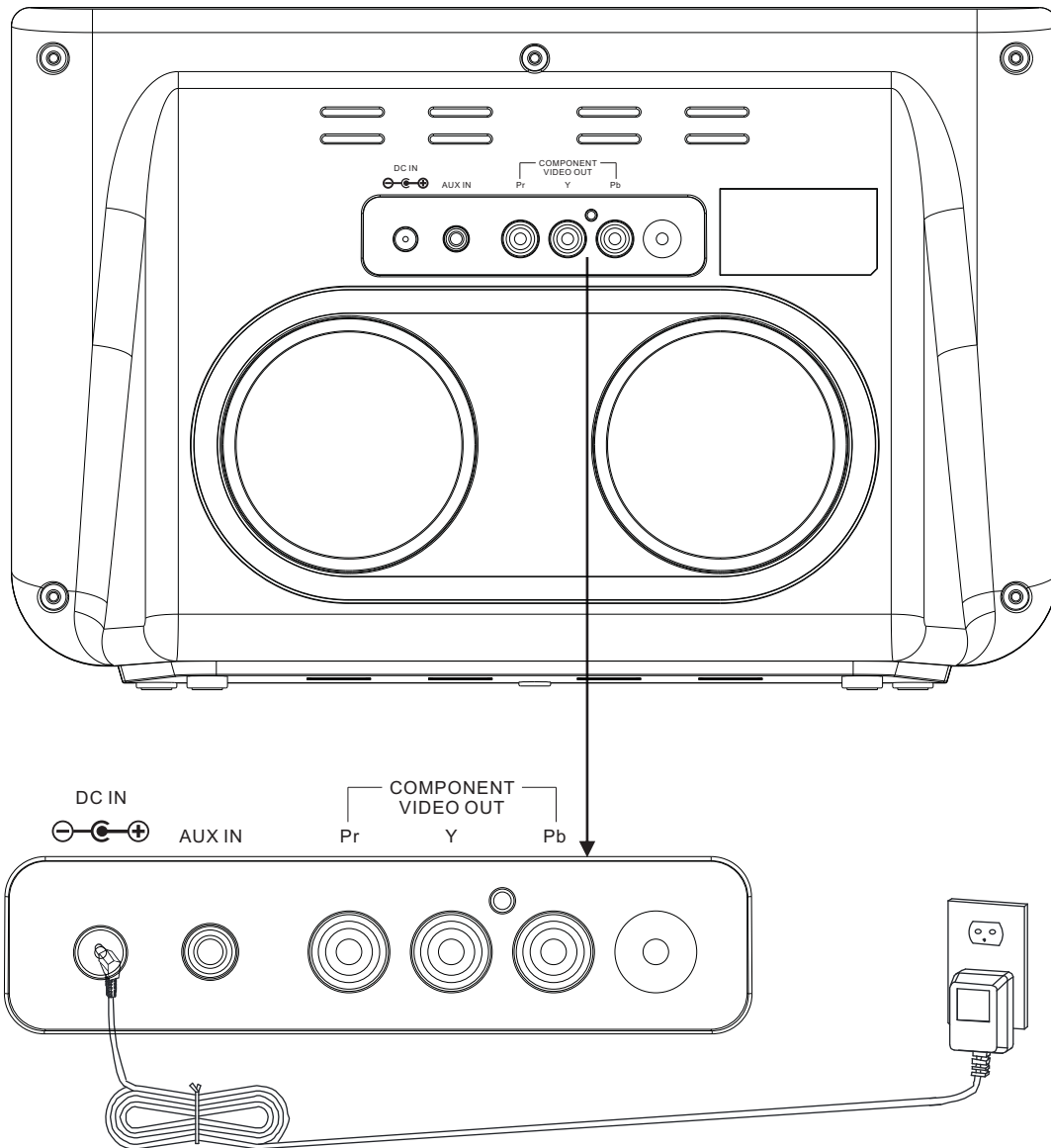

NOTES:

- *The housing of the AC adaptor may become warm during operation. This is normal.*
- *To reduce the risk of electric shock never connect or disconnect the AC adaptor while your hands are wet.*
- *Please use original AC adaptor supplied with the unit, to avoid damage to the unit.*
- *Ensure the “DC IN” plug is connected to the unit BEFORE connecting to the mains socket.*

CONNECTING EXTERNAL DEVICES

Complete the connections as shown below:

- **VIDEO** connection requires a VIDEO cable(not supplied). See “Video Operation” for details.
- **AUX** connection requires a 3.5mm audio cable(not supplied) to connect your external audio source to the **AUX** input on the back of the main unit.

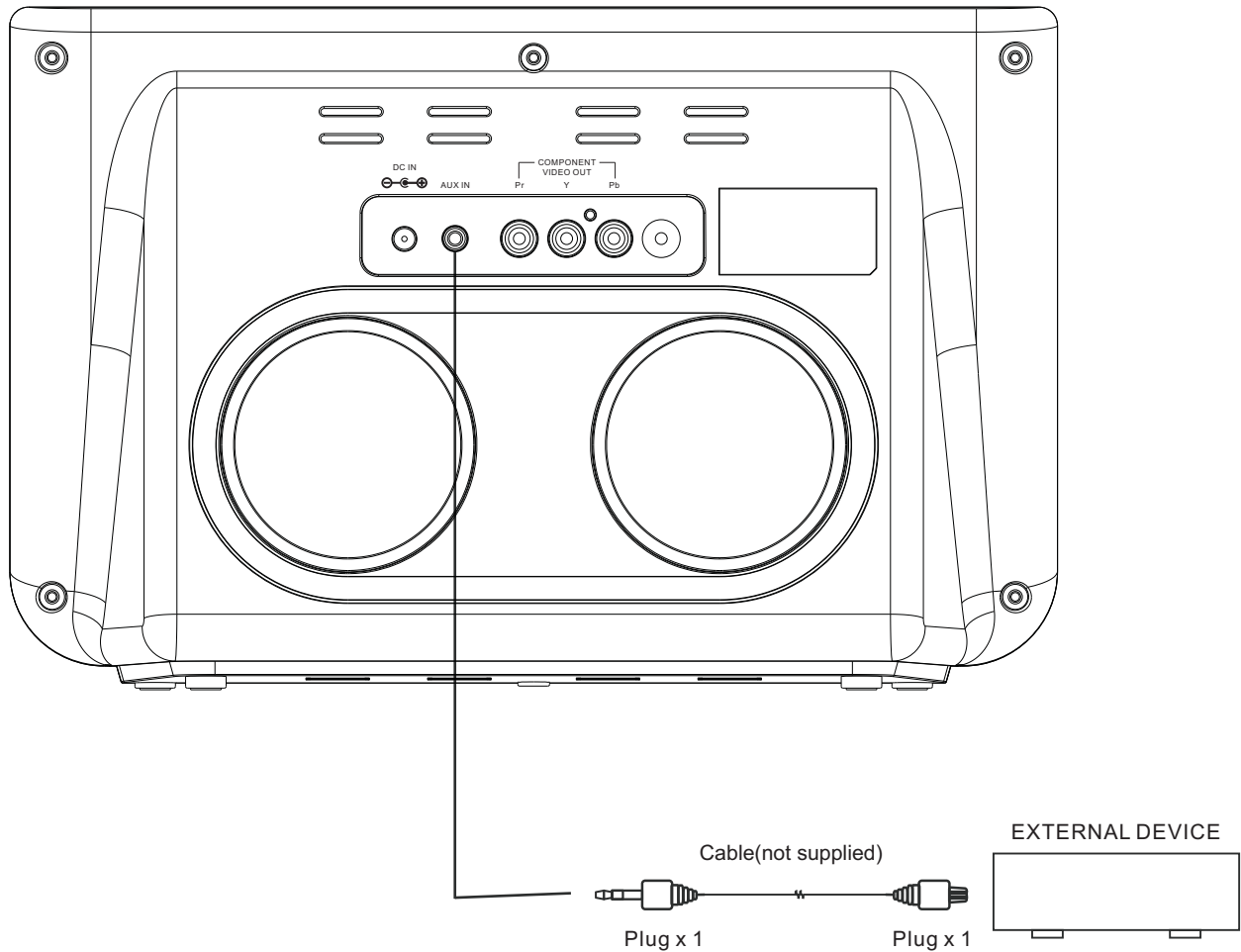

NOTE: If an iPod / iPhone / iPad is docked, it must be removed before you can listen to the **AUX** input.

LOCATION OF CONTROLS & INDICATORS

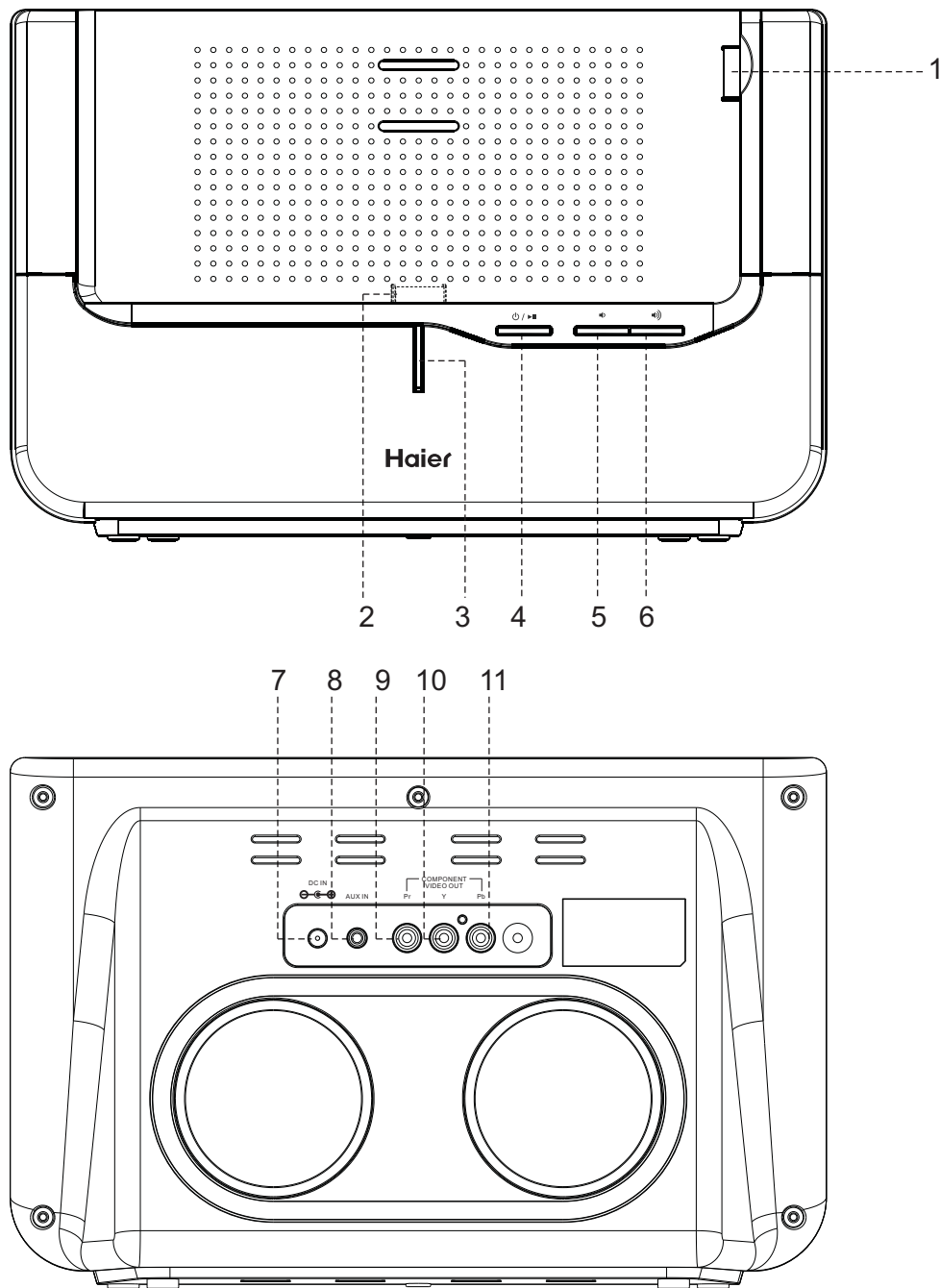

1. Universal Dock for iPad
2. Universal Dock for iPod / iPhone / iPad
3. Power Indicator
4. ⏻ / ▶⏸ POWER ON/OFF/PLAY/PAUSE Button
5. VOLUME(-) 🔊 Button
6. VOLUME(+) 🔊 Button
7. DC IN Jack
8. AUX IN Jack
9. COMPONENT VIDEO OUT Pr Jack
10. COMPONENT VIDEO OUT Y Jack
11. COMPONENT VIDEO OUT Pb Jack

REMOTE CONTROL

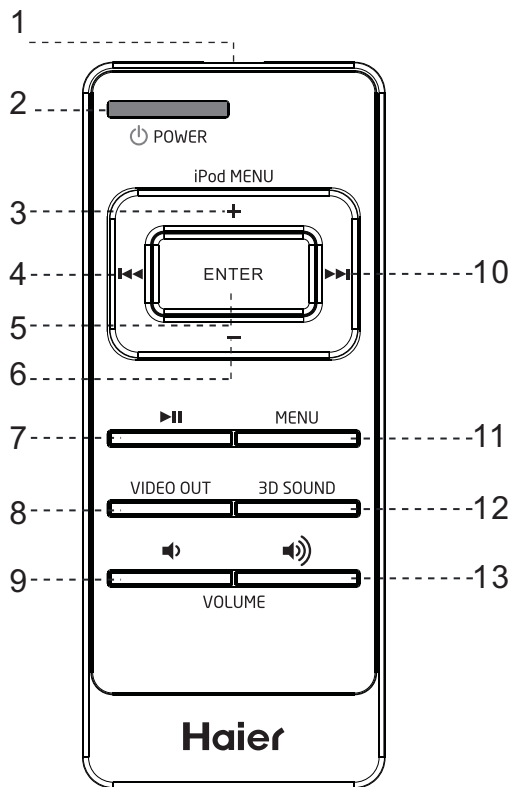

1. Remote Control Transmitter
2. ⏻ Power Button
3. iPod MENU + Button
4. SKIP <<< Button
5. ENTER Button
6. iPod MENU - Button
7. PLAY / PAUSE >>> Button
8. VIDEO OUT Button
9. VOLUME <> Button
10. SKIP >>> Button
11. MENU Button
12. 3D SOUND Button
13. VOLUME <>> Button

Using The Remote Control

The CR2032 lithium battery is already installed in the remote control. Pull out the small mylar insulation tab as shown in the illustration to begin using the remote control.

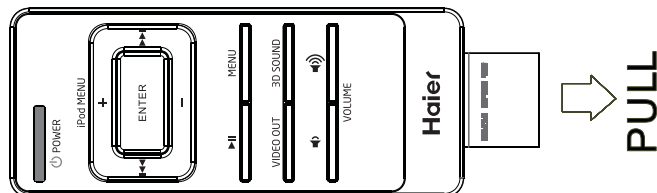

To use the remote controller, point the remote control transmitter on the remote control toward the remote control receiver on the front panel of the main unit and press the desired button. The effective range of the remote controller is approximately 20 feet. Please note that bright sunlight or artificial light may interfere with the proper operation of the remote control.

Battery Replacement

When the remote operation becomes weak or intermittent, it is time to replace the remote control battery. Pull out the battery holder, remove the old battery and install a new CR2032 battery in the holder as shown in the illustration. Slide the holder back into the remote control.

NOTE: If the battery is installed incorrectly the remote control will not work.

- Make sure that you have removed the mlar insulation tab from the remote control.

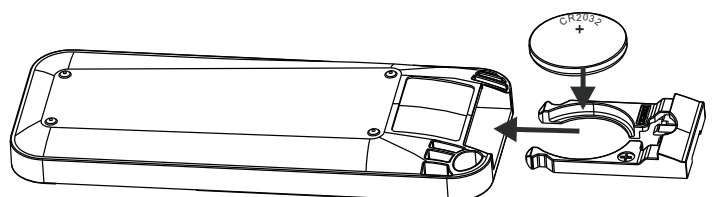

- Ensure the system is connected to an AC outlet that is always "live".

OPERATING INSTRUCTIONS

General Controls

The main functions of this system can be operated by the controls on the top panel of the main unit, or by the buttons on the remote control. If a specific function can only be operated by the remote control, this will be clearly indicated in the instructions.

When operating this system with the remote control, make sure that the IR (Infrared) transmitter on the front of the remote control is pointed at the remote sensor on the front panel of the main unit.

The effective operating range of the remote control is approximately 20 feet. Please note that bright sunlight or room lighting may interfere with the remote control operation. If the remote control is not operating properly, try reducing the brightness of the room or moving closer to the main unit. If this does not solve the problem, it may be time to change the remote control battery.

FUNCTION CONTROLS

This system has two separate docking station so that you can play and charge iPod, iPhone and iPad. Since this model is 'Made For iPhone' certified it is not necessary to place your iPhone in the Airplane mode to avoid audio interference. You will be able to make and receive calls, without interference, while the system is in operation.

Use the upper right corner dock for docking iPad model only. Use the another dock for any docking iPod model, iPad model or any iPhone model.

Docking your iPod / iPhone / iPad



Gently dock your iPod / iPhone / iPad to the 30 pin connector on the front of the unit. Do not force. If you have not already downloaded the free AppClockRadio(VIEW XL) from the iTunes App Store, you will see the following message on your iPad / iPhone or iPod Touch display: "This accessory requires an application that you do not have installed." The purpose of this message is to advise you that you must download the AppClockRadio(VIEW XL) to enjoy the enhanced features of the IPD-100. However, your iPod / iPhone / iPad will work properly with the IPD-100 even without the AppClockRadio(VIEW XL) installed.

IMPORTANT NOTES:

When you dock an iPhone, iPods or certain newer iPad in the dock there may be a slight delay before the system recognizes the device and the main menu is displayed. This is because the system and the docked device must go through an 'Authentication Process' before the docked device can accept any commands. THIS IS NORMAL AND IS NOT AN INDICATION OF ANY PROBLEM WITH YOUR SYSTEM.

The 4G iPod, iPod Classic and 5G iPod are not supported charging function with this unit. (This charging operation is not allowed by Apple)

Volume Controls

To increase or decrease the system volume, press the **VOLUME**  or  button on the remote control or on the front panel.

FUNCTION CONTROLS

If the volume is less than the default level when the unit is set to standby, when the unit is powered up again the volume will return to the default level.

If the volume is higher than the default level when the unit is set to standby, when the unit is powered up again the volume will remain at that level.

3D SOUND Button(On Remote Control Only)

This button allows you to choose between the two available audio modes, Virtual Surround and Standard (Non-Virtual Surround).

▶|| (Play/Pause)(on Remote Control Only) – Press this button on the remote control to begin playback on your iPod/iPhone/iPad. Press again to Pause playback.

▶▶ / ◀◀ Skip Forward/Back buttons(on Remote Control Only) - During playback press to skip forward or backward to the next or previous track.

MENU button(Remote control only) - Press this button to access the iPod / iPhone. This button operates exactly like the **MENU** button on the iPod/iPhone itself.

+ / - (Plus/Minus)buttons(on Remote Control Only) - After pressing the **MENU** button to access the iPod/iPhone, press the **+ / -** buttons to move up(+) or down(-) within the Menu display.

ENTER button(Remote Control Only) - After selecting your desired selection in the Menu, by using the **+ or -** buttons, press the **ENTER** button to enable that selection.

NOTES: Menu Navigation by remote control does not work on touch screen products like the iPad, the iPod nano 6th generation.

- 1.) If necessary, press the **⏻ / ▶|| POWER ON/OFF/PLAY/PAUSE** button on the main unit or press **⏻ / ON** button on the remote control to turn the system 'On'.
- 2.) To skip forward or backward to different tracks, press the **▶▶ / ◀◀** button on the remote control.
- 3.) The **MENU** button on the remote control works the same way as the **MENU** button on your iPod/iPhone. Press the **MENU** button repeatedly to access the Main Menu of your iPod/iPhone. Press the **+ / -** buttons on the remote control to navigate Up or Down through the displayed Menu list. When the desired Genre, Artist, Album, or Song is 'highlighted' on your iPod Menu display, press the **ENTER** button on the remote control to 'Enter' or 'Select' the highlighted item. If the highlighted item is a specific song, pressing the **ENTER** button will begin playback of the song.
- 4.) To pause iPod playback press the **⏻ / ▶|| POWER ON/OFF/PLAY/PAUSE** button on the main unit or **▶||** button on the remote control. Press again to release pause and resume iPod playback.
- 5.) To turn the system 'Off' completely, press and hold the **⏻ / ▶|| POWER ON/OFF/PLAY/PAUSE** button for 3 seconds on the front panel or press the **⏻** button on the remote control, until your iPod shuts off and enters the Charging mode. The top panel power LED lighting turns "off".

VIDEO OPERATION

Connecting the Video Cord to View a Video/Picture from iPod/iPhone/iPad

When viewing a video/picture from iPod/iPhone/iPad on your TV, use a component video cord (not supplied) to connect the COMPONENT VIDEO OUT jack on the unit and the component video input on your TV.

- After you have connected the unit, change the video input mode on your TV. For details, also refer to the instruction manual for your TV.

The below diagram show the connection options available.

NOTE: Consult your iPod documentation for details on how to enable video output on you model of iPod / iPhone / iPad.

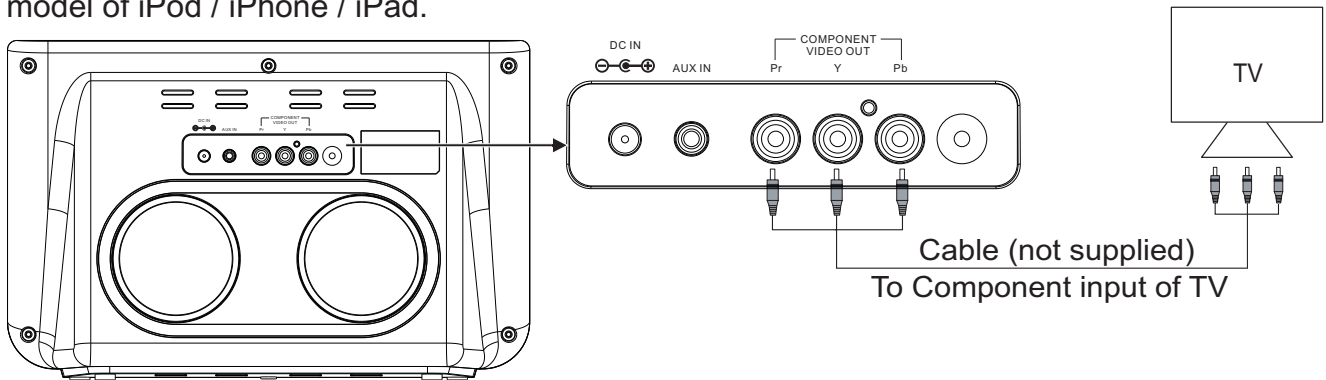

The VIDEO OUT to TV is only available for vertical docking connector the upper right corner dock is not supported the VIDEO output to TV for the iPad.

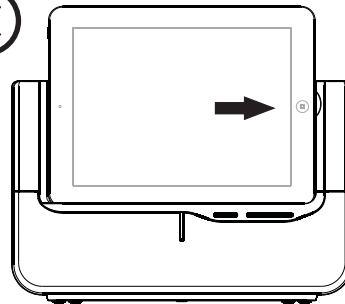
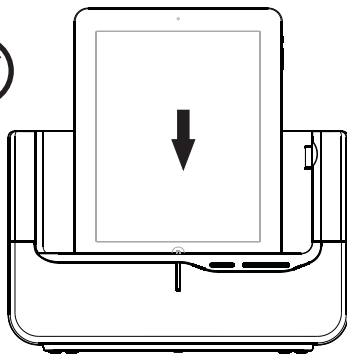

Remarks:

- When you have your iPod outputting video and the unit connected to your TV, you may need to change the output setting to TV output.
- Press the **VIDEO OUT** button on the remote control to escape the current video playback, then press **ENTER** or Play(iPad) to resume on TV screen.

Video play on iPod / iPhone / iPad \longleftrightarrow TV out with Component out

NOTES:

- Due to the software used in iPod Nano 3G & iPod Classic, to change the video the video output mode you will need to press the **MENU** button to escape the current video playback, then press **ENTER** to resume.
- Component video output to television is supported by iPod nano (3rd, 4th and 5th generation), iPod touch (2nd generation), and iPod classic at 480p or 576p resolution; and by iPod touch (1st generation), iPhone, iPhone 3G, iPhone 3GS, iPhone 4, and iPad at 480p or 576p resolution.

AppClockRadio(VIEW XL) OPERATION

“AppClockRadio(VIEW XL)” : the app-enhanced experience

AppClockRadio(VIEW XL) is an interactive app with IPD-100 for iPhone / iPod and iPod touch Users. In addition to a full screen clock - with weather, iPod controls, FM Radio and Clock with wakeup settings such as alarms, music selection, Favorite Radio Station.

“app-enhanced FM tuner”

Works with IPD-100 “App-Enhanced ” products for control the FM Radio.
30 preset stations.

Music and Radio alarm clock

Choose hi-fi tones or music playlists from your entire iPod library or Favorite Radio Station.

Weekday alarm calendar

Program alarms to repeat for any day of the week combo: never, everyday, weekday, weekend & custom Sleep and snooze timers, and much more...

“app-enhanced preset equalizer”

Works with IPD-100 “App-Enhanced” products for audio performance.
3D / Jazz / Rock / Classic / Custom

Weather widget

Quickly view the current weather or forecast

Set up, download, and launch

1. Plug IPD-100's included AC adaptor into a wall outlet
 2. Download and install “AppClockRadio(VIEW XL)” (it's a free app):
 - Option 1 - Docking your iPhone or iPod touch or iPad onto the IPD-100 will tell you that
“This accessory requires an application you do not have installed.
Would you like to install it from the APP store?”
 - Option 2 - Visit the app store via iTunes or your iPod touch / iPhone, search for
“Haier AppClockRadio” and download.
 3. Launch “AppClockRadio(VIEW XL)”, your social music alarm clock app
- NOTE:** “AppClockRadio(VIEW XL)” is only available for the iPad, iPhone, and iPod touch.

AppClockRadio(VIEW XL) OPERATION

Home Screen

Launching “AppClockRadio(VIEW XL)” will bring you to the clock home screen from which you can control and access all other settings

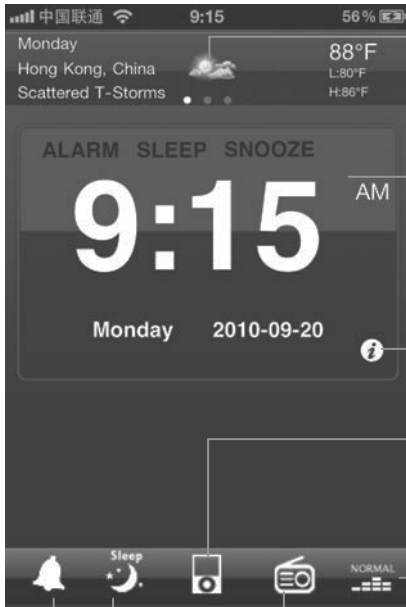

Weather Widget

- Swipe to view contextual weather forecast for the day ahead
- Change temperature scale, location or turn off via weather settings

Clock with Custom Background

- Change from 12 or 24 hour mode
- Select any photo in your library for your home screen background

Settings

- Click icon to access app settings

iPod controls

- Click the iPod icon to bring up the iPod transport music control panel

EQ Function

- Click icon to access EQ settings

Radio settings

- Click the Radio icon to select the FM Radio station.

Sleep setting

- Click to access sleep settings

Alarm setting

- Click alarm icon to view alarm settings view

App Settings

Manage your setting.



Click to save and return to the app home screen

Select a custom background for the home screen from your photo library

Select “Auto Lock” ON/OFF

Select “Show Seconds” ON/OFF

Select “Show Weekday ON/OFF

Select 12 Hour with AM/PM or 24 Hour

Slide to control your screen brightness settings for a bedtime event

Manage your weather settings

AppClockRadio(VIEW XL) OPERATION

Alarm Settings



Select which day of the week you want the alarm to sound: (Never, Everyday, Weekday, Weekend or Custom)

Select what alarm tone, music with playlist or favorite Radio station you want to sleep or wake-to

Select "SNOOZE" time

Set the Alarm Name

Set the Alarm time

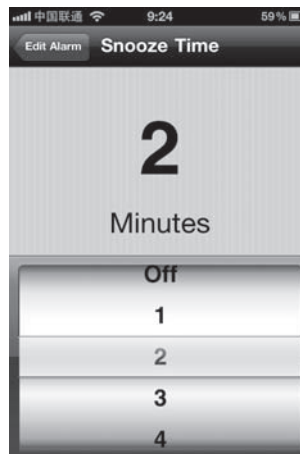

Press Sleep icon ' when you're ready to go to sleep...

1.Sleep Stats - starts a log of the time you went to bed and starts calculating sleep duration

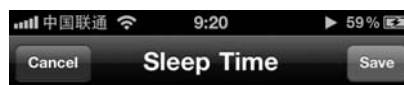

2
Minutes

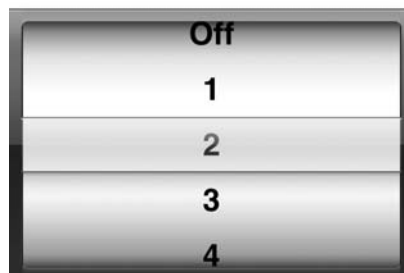

AppClockRadio(VIEW XL) OPERATION

iPod Music Play Settings

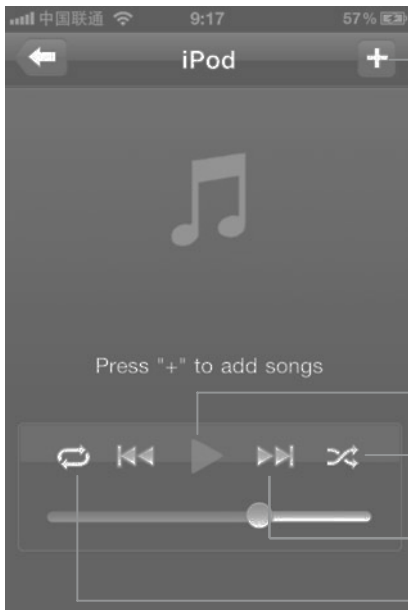

Click to add desired songs

Play / Pause

Select Shuffle

Skip UP / DOWN

Select Repeat

Preset Equalizer Settings



Slide to control your desired sound setting of EQ

Scroll to select the favorite EQ setting
3D, Jazz, Rock, Classic, or Custom

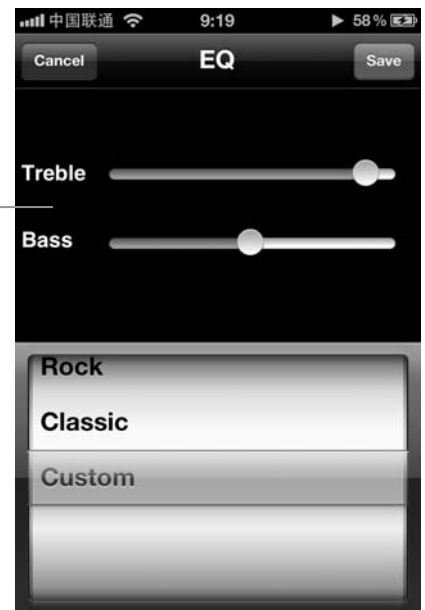

AppClockRadio(VIEW XL) OPERATION

FM Radio Settings



Click one time to skip frequency. Click and hold to Start Auto Search

Click to preset the favorite stations



Select your Favorite station in this list.



Select your Area Region.

Select Stereo / MONO

Learn More

For more questions or to learn more, visit our community forum at <http://www.haieramerica.com/support>

AppClockRadio(VIEW XL) OPERATION

FAQ

1. iPod Integration - Can I sleep or wake to my iPod library?

Yes. "AppClockRadio(VIEW XL)" is specially designed with iPod support and built-in iPod controls for navigating your music and wakeup Playlists, Artists, Songs.

2. My "AppClockRadio(VIEW XL)" app software alarm did not sound at the specified time

A. Make sure that the volume of the iPhone or iPod touch is not set at 0 and verify your wake-to volume settings.

B. The iPhone OS does not currently support 3rd party applications running if the app is closed, which means that alarms won't work if you exit the app. This is why we suggest customers use our App-enhanced Speaker Systems to make sure you always have a back-up alarm. If the app exits, simply relaunch the app and your alarms will automatically pick up where they left off

C. If you dock your iPod or iPhone into a speaker dock overnight, the speaker dock must be powered ON to hear your alarms in the morning. Because of Apple requirements for devices that both charge and play audio, the iPhone and iPod touch's built-in speakers are deactivated and your alarm will not to sound if you do not leave the power ON. This is another reason why we suggest customers use our App-enhanced Speaker Systems to make sure you don't have to remember to leave the power on before going to bed.

3. What happens if I exit the app?

The iPhone OS does not currently support 3rd party applications running if the app is closed, which means that alarms won't work if you exit the app. This is why we suggest customers use our App-enhanced Speaker Systems to make sure you always have a back-up alarm. If the app exits, simply relaunch the app and your alarms will automatically pick up where they left off.

4. My app crashed:

Crashes can happen for reasons in and out of our control. Sometimes they just happen, and you can reload the app and never see it again.

Believe us, when your app crashes, we feel terrible, but rest assured, we find out about it through our crash log developer system so that we can track bugs and make improvements.

But also, don't hesitate to email us if there is something you are doing over and over and you keep crashing. Sometimes crashes are hard to reproduce and depend on your setup, so we never hate hearing about it so that we can make sure App is working properly for all of our users.

5. My iPhone screen auto-locks while it is running.

If you manually lock your iPhone screen while our app is running, it will disable the auto-lock-prevention system for the remaining time you run the app session. If you wish to enable auto-lock-prevention, please exit and relaunch AppClockRadio(VIEW XL).

Don't worry though, the alarms will still work even if the screen is locked.

TROUBLESHOOTING GUIDE

Symptom	Possible Cause	Solution
iPod / iPhone / iPad Player(Example "iPod")		
Unit does not respond (no power)	AC adaptor is not plugged into a wall outlet or the connector is not plugged into the DC IN jack on the back of the unit.	Plug the AC adaptor into a wall outlet and plug the connector into the DC IN jack on the unit.
	Using no or wrong iPod insert	Make sure the dock insert is the proper fit for the iPod.
iPod does not dock properly	iPod did not install properly	Remove the iPod from the dock and check for obstruction on the connections in the dock and on the iPod. Then reseal it in the dock.
iPod does not respond to the unit	iPod is not installed properly	Remove the iPod from the dock and check for obstruction on the connections in the dock and on the iPod. Then reseal it in the dock.
	iPod is locked up	Please make sure your iPod is working properly before docking into the unit. Please refer to the iPod manual for details.
	Using first or second generation iPod, iPod shuffle or other devices.	This unit cannot control those iPod or other devices.
iPod did not charge up	iPod is not installed properly	Remove the iPod from the dock and check for obstruction on the connections in the dock and on the iPod. Then reseal it in the dock.
	iPod is locked up/frozen	Please make sure your iPod is working properly before docking into the unit. Please refer to the iPod manual for details.
	iPod battery has problem	Please refer to the iPod manual for details.

Remarks:

If trouble shooting does not eliminate the problem, disconnect the DC IN plug from the back of unit and reconnect after a few seconds. This resets the unit to it's factory default settings and results in the deletion of all previous settings.

TECHNICAL SPECIFICATION

1. General

Power requirements	AC Adapter Model: GPE365-100360-1 Input: AC 100-240V ~ 50/60Hz 1A Output: DC 10V 3.6A 36W
Power consumption	30W
Dimensions of main unit	310.0mm(L) x 200.0mm(H) x 121.0mm(D)
Weight of main unit	1.65 Kg

2. Amplifier

Power Output	10W x 2 THD 10%
--------------	-----------------

3. Speaker system

Impedance	8 Ω 2" Speaker x4 / 2.5" passive woofer x2
-----------	---

4. AUX IN



















Input	Φ 3.5mm
Max voltage	1 V
Impedance	47 K Ω

5. Remote Control

Power consumption	3V
Battery size	CR2032

Specifications subject to change without notice.

APPLE DEVICE COMPATIBILITY CHART

 <p>iPod mini 4GB 6GB</p>	 <p>iPod 4th generation 20GB 40GB</p>	 <p>iPod 4th generation (color display) 20GB 30GB 40GB 60GB</p>
 <p>iPod 5th generation(video) 30GB 60GB 80GB</p>	 <p>iPod nano 1st generation 1GB 2GB 4GB</p>	 <p>iPod nano 2nd generation (aluminum) 2GB 4GB 8GB</p>
 <p>iPod nano 3rd generation(video) 4GB 8GB</p>	 <p>iPod nano 4th generation(video) 5th generation (video camera) 8GB 16GB</p>	 <p>iPod nano 6th generation 8GB 16GB</p>
 <p>iPod classic 80GB 160GB</p>	 <p>iPod classic 2nd generation 120GB</p>	 <p>iPod touch 1st/2nd generation 8GB 16GB 32GB</p>
 <p>iPod touch 4th generation 8GB 32GB 64GB</p>	 <p>iPhone 4GB 8GB 16GB</p>	 <p>iPhone 3G 8GB 16GB</p>
 <p>iPhone 3GS 8GB 16GB 32GB</p>	 <p>iPhone 4 16GB 32GB</p>	 <p>iPad 16GB 32GB 64GB</p>

"Made for iPod," "Made for iPhone," and "Made for iPad" mean that an electronic accessory has been designed to connect specifically to iPod, iPhone, or iPad, respectively, and has been certified by the developer to meet Apple performance standards. Apple is not responsible for the operation of this device or its compliance with safety and regulatory standards. **Please note that the use of this accessory with iPod, iPhone or iPad may affect wireless performance.**

WARRANTY

This Haier brand product, when shipped in its original container, will be free from defective workmanship and Materials, and agrees that it will, at its option, either repair the defect or replace the defective product with a New or re-manufactured equivalent at no charge to the purchaser, for parts or labor for the periods set forth Below:

This warranty does not apply to the appearance of the product or the exterior of the product, which has been Damaged or defaced, altered or modified in design or construction. It does not apply to the additional Excluded items set forth below:

The warranty commences on the date the item was purchased and the original purchase receipt must be Presented to the authorized service center before warranty repairs are rendered. The limited warranty described herein is in addition to whatever implied warranties may be granted to purchasers by law. ALL IMPLIED WARRANTIES INCLUDING THE WARRANTIES OF MERCHANT ABILITY AND FITNESS FOR USE ARE LIMITED TO THE PERIOD(S) FROM THE DATE OF PURCHASE SET FORTH BELOW. Some states do not allow limitations on how long an implied warranty lasts, so the above limitation may not apply to you. Neither the sales personnel of the seller nor any other person is authorized to make any warranties other than those described herein, or to extend the duration of any warranties beyond the time period described herein on behalf of Haier.

The warranties described herein shall be the sole and exclusive warranties granted by Haier and shall be the sole and exclusive remedy available to the purchaser. Correction of defects in the manner and for the period of time described herein, shall constitute complete fulfillment of all abilities and Responsibility of Haier to the purchaser with respect to the product, and shall constitute full satisfaction of all claims, whether based On contract, negligence, strict duality or otherwise. In no event shall Haier be liable, or in any way responsible for any damages or defects in the product which were caused by repairs or attempted repairs performed by anyone other than an authorized service center or dealer; nor shall Haier be liable, or in any way responsible for incidental or consequential economic or property damage. Some states do not allow the Exclusion of incidental or consequential damages, so that above exclusion may not apply to you.

THIS WARRANTY GIVES YOU SPECIFIC LEGAL RIGHTS. YOU MAY ALSO HAVE OTHER RIGHTS WHICH VARY FROM STATE TO STATE. Warranty period for this product: 90 days for Labor, and one Year for parts. Additional items excluded from warranty coverage: non rechargeable batteries.

Where to obtain service: For the location of the nearest Haier authorized service center or to obtain product Literature, accessories, supplies or customer assistance, please call 1-877-337-3639.

What to do to obtain service: ship or carry in your product to an authorized service dealer or center .Be Sure to have proof of purchase. If you ship the product, be sure it is packaged carefully.

Haier America
New York, NY 10018